

# FAT-I-29 Optical Fiber Distribution Box Specifications

Version:1.0



Official website



Technical specification



Installation guide



Download CN ver

# FAT -I-29 type fiber optic distribution box specifications

FAT-I-29 optical fiber split-box, used in the terminal access link of FTTH optical fiber to household access system, is an ideal supporting equipment for wiring between optical nodes and terminal devices in optical fiber transmission network, with the function of optical fiber storage and splitting, wiring flexible scheduling, suitable for outdoor pole and wall hanging installation. The maximum capacity is 48 cores, up to 4 1:8 micro-optical splitters can be installed, and 1 straight optical cable and 3 split optical cables or multiple leather cable cables of different diameters can be installed. It can realize the splicing or splitter wiring of ordinary optical cable.



## Reliable sealing

The shell of the optical fiber split-box and the inlet and outlet holes of the optical fiber are mechanically sealed with reliable silicone sealing rings, and the protection level is above IP55. The optical cable inlet and outlet hole sealing ring has different specifications of aperture to choose from, which can meet the different diameters of optical cable inlet and outlet sealing, and the sealing performance of the product is better.



## Modular design

The optical splitting and distribution area are separated from the optical fiber connection area, and the internal fiber routing is clear, which facilitates the winding and fixing of optical fibers. Independent areas are not affected, making installation and maintenance more convenient. The number of splices and fixed brackets can be increased or decreased according to the capacity. Optical fibers with loose sleeves can be coiled and stored. The bending radius of the optical fibers is greater than 30mm.



## Powerful Features

Support optical cable welding, splitting, wiring, splitting, docking and through inventory. It can be mounted on wall and pole. Ground the metal parts in the fiber distribution box through the grounding device and grounding cable.

## Excellent practicabilit



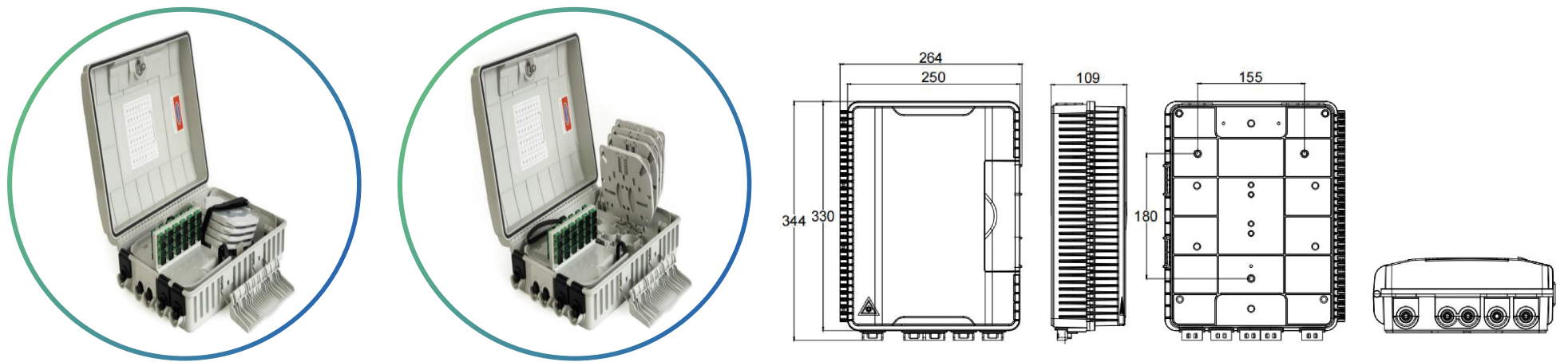

The shell is made of modified PC material, and the internal metal parts are made of 304 stainless steel material, which can meet the service life of more than 25 years (depending on the environment), and has good impact resistance and corrosion resistance. If necessary, the box can also be fitted with a valve nozzle for the air tightness test of the box.

# FAT -I-29 type fiber optic distribution box specifications

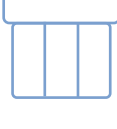

Product specifications	
Maximum capacity	48 cores
Capacity of each splice tray	6-12 core/tray
Maximum number of splice trays	max 4 pcs
Number of optical cable entrance and exit tubes	1 oval port/ 3 branch ports

## Ordering Guide | Accessories information

-  Product number  
FAT-I-29
-  Product size  
335\*264.5\*111.5mm
-  Product weight  
1.9kg
-  Qty/CTN  
1set
-  Inner carton size  
410\*325\*190mm
-  Outer carton size

Standard accessories			
1. Seal tape		6. Nylon tie	
2. Installation tape		7. Desiccant	
3. Abrasive cloth		8. Wall mounting kit	
4. Heat shrinkable protective sleeve		9. Earthing wire	
5. Labeling paper		10. Hose clamp	

# To the future together.

 [www.ztong.com](http://www.ztong.com)

 [info@ztong.com](mailto:info@ztong.com)

 Tel:86-0574-62498928

 Ningbo Zhantong Telecom Equipment Co.,Ltd.

 Fumin Industrial Zone,Moushan,Yuyao City,Zhejiang,China