

FAT-115 Optical Fiber Distribution Box Specifications

Version:1.0

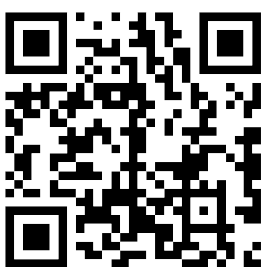

View website



Download CN ver

FAT-115 type fiber optic distribution box specifications

FAT-115 type optical fiber distribution box is used in the terminal access link of FTTH optical fiber to the access system. It is an ideal supporting equipment for wiring between optical nodes and terminal equipment in optical fiber transmission networks. It has the ability to support optical fiber storage. It has the function of flexible scheduling of light splitting and wiring. The protection level of this product reaches IP65, and is suitable for outdoor pole and wall-mounted installation. You can install a miniature optical splitter as needed. The maximum capacity 12core, It has 3pcs input/output optical cable ports. Meantime, It can install an SC adapter and use an optical fiber quick connector to lead out the fiber optic cable.



Reliable sealing

The input and output cable ports are sealed with silicone sealing rings. The cable ports are tightened by the nut screws, the sealing performance will be better.

Modular design

Optical fiber splicing tray and storage tray adopt a friendly modular structure design.

Supports coiled storage of optical fibers with loose tubes, and the bending radius of the optical fiber is greater than 30 mm.



Powerful Features

Supports splicing, splitting, wiring, branching, docking and pass-through inventory of optical cables.

Supports wall-mounting and pole installation. Through the grounding device and grounding wire, the metal parts inside the distribution box are supported to be grounded.

Excellent practicability

The fiber distribution box shell is made of modified PC+ABS material, and the internal metal parts are made of high-quality steel plate materials. It can meet the service life of more than 20 years (depending on the environment), and has good impact resistance and resistance. Corrosion properties.



FAT-115 type fiber optic distribution box specifications

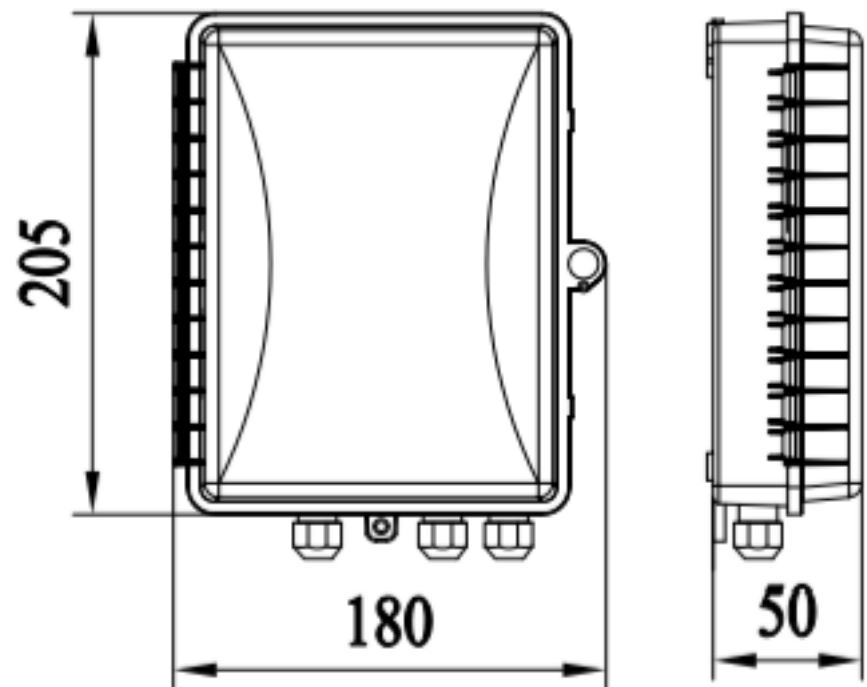
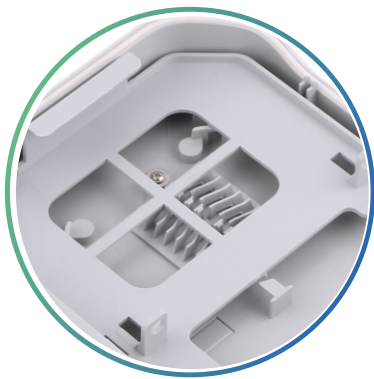

Product specifications

Maximum capacity	12 cores
Capacity of each splice tray	12 core/tray
Maximum number of splice trays	max 1 pcs
Number of optical cable entrance and exit tubes	3 main cable ports

Ordering Guide

Accessories information



Product number
FAT-115



Product size
205*180*50mm



Product weight
0.6kg



Qty/CTN
20 set







Inner carton size
225*210*60mm



Outer carton size
470*440*340mm

Standard accessories

1. Nylon tie		4. Wall mounting kit	
2. Key		5. Pole mounting kit	
3. Heat shrinkable protective sleeve			

To the future together.

 www.ztong.com

 info@ztong.com

 Tel:86-0574-62498928

 Ningbo Zhantong Telecom Equipment Co.,Ltd.

 Fumin Industrial Zone,Moushan,Yuyao City,Zhejiang,China