

FAT-145型 光纤分纤箱产品规格书

版本:V1.0



查看网站



下载英文版

FAT-145型光纤分纤箱产品规格书

FAT-145型光纤分纤箱,应用于FTTH光纤到户接入系统中的终端接入环节中,是光纤传输网络中光节点及终端设备之间配线的理想配套设备,具有对光纤存储及分光、配线灵活调度的功能,该产品防护等级达到IP68以上,适合室外抱杆和挂壁安装使用。分纤箱内部可安装16个SC适配器,根据需要可安装1只1:8或1只1:16 PLC微型光分路器,最大容量96芯,最多有1个直通光缆进出孔和2个分歧光缆出孔及16个皮线光缆出孔,通过光纤快速连接器引出到户。



可靠的密封性能

该分纤箱的光缆进出口采用硅胶密封圈密封,使用螺钉或螺母压缩紧固即可实现快速安装,壳体采用硅胶密封条密封,整体密封性能更好。



模块化结构设计

光纤熔接盘及储存盘采用友好的模块化结构设计,可以根据容量来增加或减少熔接盘的数量,以满足不同客户的使用要求。支持带松套管的光纤盘绕储存,光纤弯曲半径大于30mm。

强大的产品功能

支持光缆的熔接、分光、配线、分歧和直通盘存。

支持挂壁、抱杆、架空安装。

通过接地装置和接地线,支持分纤箱内金属件引出接地。

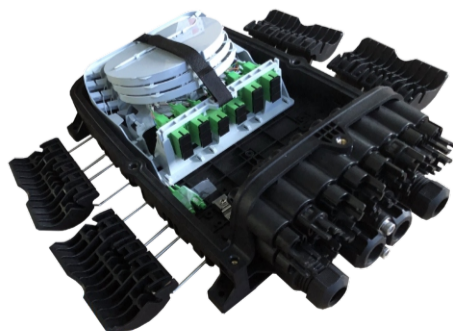

良好的材料配置

分纤箱壳体采用改性PP+GF材料制成,内部金属件采用优质钢板材料生产,能够满足使用寿命达到20年以上(取决于环境),具有良好的抗冲击和抗腐蚀特性。

FAT-145型光纤分纤箱产品规格书

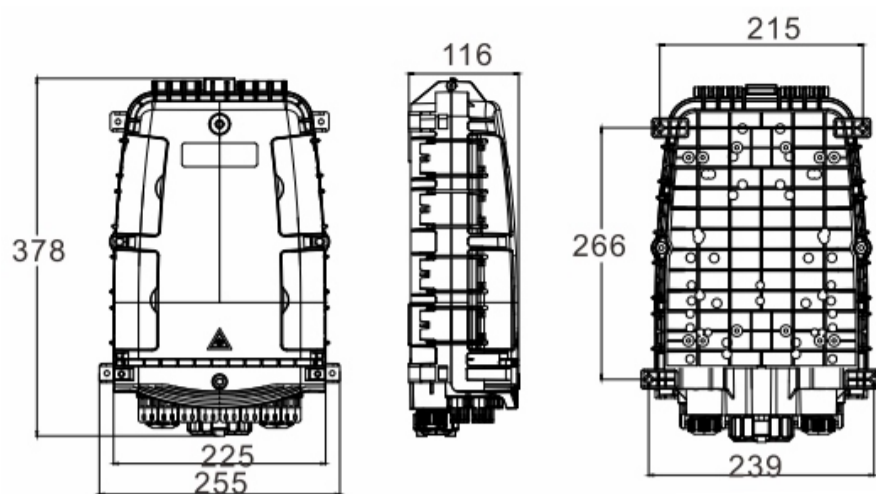
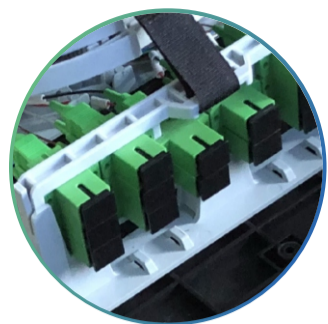











产品规格	熔接盘 A	熔接盘 B	熔接盘 C
最大容量	48芯	64芯	24芯
每张熔接盘容量	12芯/张	8芯/张	6芯/张
最大熔接盘数量	4张	8张	4张
光缆进出管数量	1根直通光缆,2根分歧光缆,16根皮线光缆		

产品规格	熔接盘 D	熔接盘 E	熔接盘 F
最大容量	96芯	96芯	96芯
每张熔接盘容量	12芯/张	24芯/张	24芯/张
最大熔接盘数量	8张	4张	4张
光缆进出管数量	1根直通光缆,2根分歧光缆,16根皮线光缆		

订货指南 配件信息

-  产品型号
FAT-145
-  产品尺寸
378*255*116mm
-  产品重量
1.5kg
-  装箱数量
8套
-  小箱尺寸
385*260*125mm
-  大箱尺寸
540*405*540mm

标准配件			
1.M6内六角扳手		9.挂壁安装件	
2.熔接保护套管		10.抱杆安装件-A	
3.光纤保护管		11.抱杆安装件-B	
4.钥匙		12.架空安装件	
5.喉箍		13.螺母扳手	
6.尼龙扎带		14.皮线光缆盘存支架	
7.堵头		15.说明书	
8.光缆密封螺母扳手			

To the future together.

 www.ztong.com

 info@ztong.com

 电话:0574-62498928

 浙江省余姚市牟山镇富民工业区

 宁波展通电信股份设备有限公司